

LP SERIES-GENERAL PURPOSE

LP6-7.8 (6V7.8Ah)

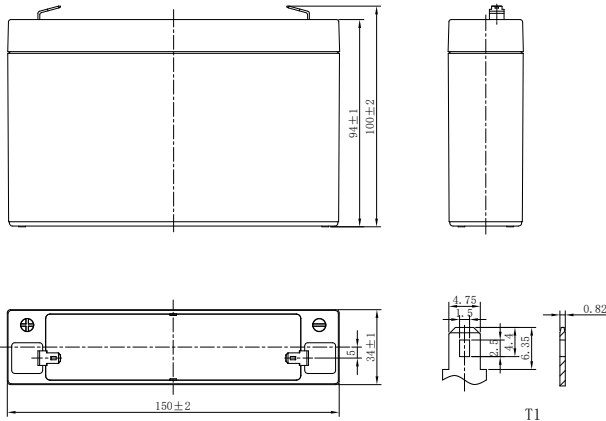

CHARACTERISTICS

Item	Specifications	
Rated Voltage	6V	
Nominal Capacity (25°C)	C ₂₀ : 1.75V/cell	7.8Ah
Dimension	Length	150mm (5.91inches)
	Width	34mm (1.34inches)
	Container Height	94mm (3.70inches)
	Total Height	100mm (3.94inches)
Approx Weight	1.28kg (2.82lbs)	
Terminal	T1/T2	
Container Material	ABS (UL94 HB or V-0 optional)	
Short-circuit current	218.4A	
Internal Resistance (25°C)	Approx 12 mΩ (Fully charged)	
Operating Temp. Range	Discharge	-15~50°C (5~122°F)
	Charge	-20~40°C (-4~104°F)
	Storage	-15~40°C (5~104°F)
Nominal Operating Temp. Range	25±3°C (77±5°F)	
Max. Charging Current (25°C)	0.3C	
Charge voltage (25°C)	Standby Use	Cycle Use
	2.25-2.30V/cell	2.35-2.45V/cell
Temp. Coefficient	-3mV/cell/°C	
	-5mV/cell/°C	
Effect of temp. to Capacity	40°C (104°F)	103%
	25°C (77°F)	100%
	0°C (32°F)	86%
Self Discharge	≤3% per month at 25°C (77°F).	
	LP series batteries may be stored up to 6 months at 25°C (77°F) and then a freshening charge is required. For higher temperatures the time interval will be shorter.	

DISCHARGE TABLE

Constant Current Discharge (Amperes) at 25°C (77°F)																
F.V/Time	5min	10min	15min	20min	30min	45min	1h	1.5h	2h	3h	4h	5h	6h	8h	10h	20h
1.85V/cell	29.4	20.2	15.4	12.5	9.19	6.64	5.38	3.88	2.99	2.11	1.64	1.37	1.15	0.904	0.739	0.391
1.80V/cell	31.6	21.4	16.2	13.0	9.47	6.82	5.51	3.96	3.05	2.15	1.67	1.39	1.17	0.917	0.749	0.396
1.75V/cell	33.3	22.2	16.7	13.3	9.72	6.97	5.63	4.03	3.11	2.18	1.69	1.40	1.18	0.927	0.757	0.400
1.70V/cell	34.9	23.1	17.3	13.7	9.97	7.13	5.73	4.10	3.15	2.21	1.71	1.42	1.19	0.937	0.764	0.403
1.67V/cell	36.1	23.8	17.7	14.0	10.1	7.24	5.82	4.15	3.19	2.23	1.73	1.43	1.20	0.944	0.770	0.406
1.60V/cell	38.3	24.8	18.3	14.4	10.4	7.42	5.95	4.24	3.25	2.28	1.76	1.46	1.22	0.957	0.780	0.411
Constant Power Discharge (Watts/cell) at 25°C (77°F)																
F.V/Time	5min	10min	15min	20min	30min	45min	1h	1.5h	2h	3h	4h	5h	6h	8h	10h	20h
1.85V/cell	55.7	38.4	29.5	24.0	17.8	12.9	10.5	7.57	5.86	4.15	3.24	2.70	2.27	1.79	1.47	0.782
1.80V/cell	59.3	40.4	30.8	24.9	18.2	13.2	10.7	7.71	5.96	4.21	3.28	2.73	2.30	1.82	1.49	0.791
1.75V/cell	61.8	41.7	31.6	25.4	18.6	13.4	10.9	7.82	6.05	4.27	3.32	2.76	2.33	1.84	1.50	0.800
1.70V/cell	64.1	43.1	32.5	26.0	19.0	13.7	11.0	7.94	6.12	4.32	3.36	2.80	2.35	1.85	1.52	0.807
1.67V/cell	65.7	44.1	33.2	26.5	19.3	13.9	11.2	8.02	6.18	4.36	3.39	2.82	2.37	1.87	1.53	0.813
1.60V/cell	68.4	45.4	34.1	27.2	19.7	14.1	11.4	8.16	6.28	4.43	3.44	2.85	2.40	1.89	1.54	0.822

LP SERIES-GENERAL PURPOSE

LP6-7.8 (6V7.8Ah)



APPLICATIONS

- Uninterruptable Power Supply (UPS)
- Electric Power System (EPS)
- Emergency backup power supply
- Alarm and security system
- Communication power supply
- DC power supply
- Auto control system

GENERAL FEATURES

- 5 years design life (25°C)
- Lead calcium alloy, sealed design, no watering required
- Puncture resistant micro-porous glass mat separators extend life
- Unique technology optimizes power capacity, cell consistency, and long-term reliability
- Designed for a wide range of applications

STANDARDS

- Compliance with IEC 60896 standards, EU Battery Directive
- UL, CE Approved
- Manufactured in Leoch@IATF 16949, ISO 45001, ISO 9001 and ISO 14001 certified production facilities

Discharge Characteristics

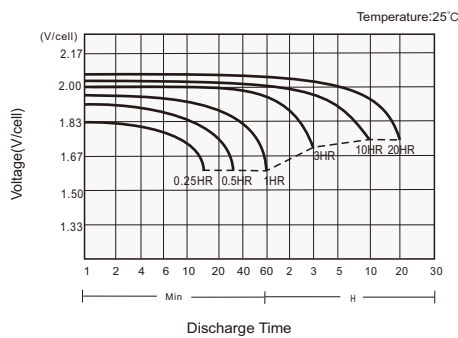

Charging Characteristics

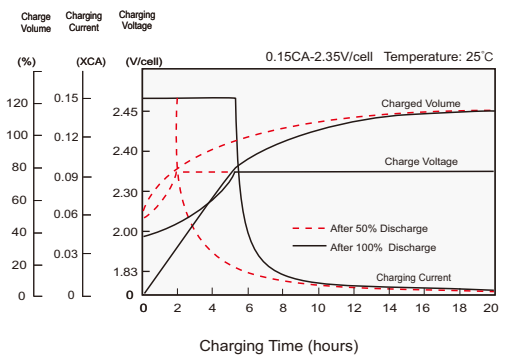

Effects of Temperature on Capacity

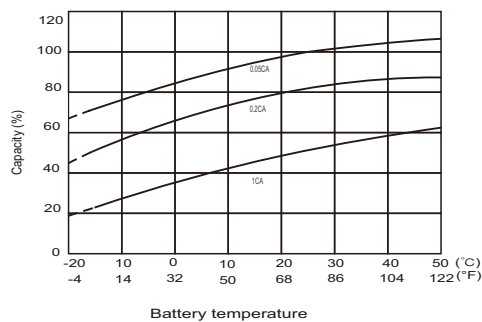

Self Discharge Characteristics

